

# Dressing Up

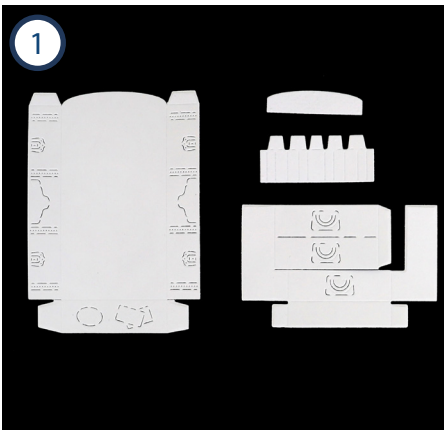

1. Cut the dressing up pieces ready to use.



2. Fold along the score lines of the A and B die cuts as shown.



3. Assemble the A die cut to create the dressing up body. Secure by sticking the tabs to their corresponding sides.



4. Create the drawers by folding along the score lines and secure by sticking down the tabs.



5. Insert the drawers piece into the body. Use the extra dies to decorate as desired.

# Hot Air Balloon

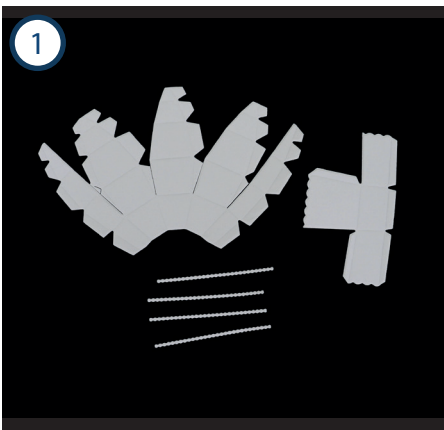

1. Cut the hot air balloon pieces ready to use.



2. Mountain fold along the score lines of the A die cut.

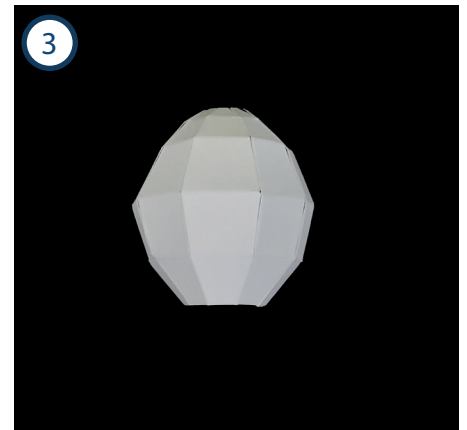

3. Assemble the balloon by sticking the tabs to their corresponding sides.



4. Valley fold along the score lines of the B die cut.

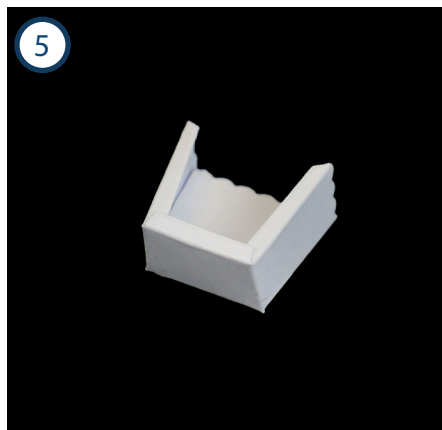

5. Assemble the basket by sticking the tabs to their corresponding sides.



6. Stick the ropes to the balloon and the basket to the bottom of the ropes. Decorate with the remaining dies as desired.

# Jukebox

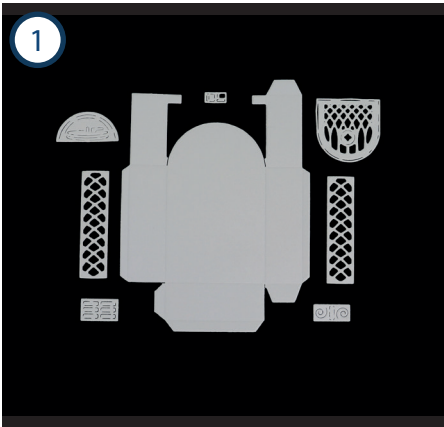

1. Cut the jukebox pieces ready to use.



2. Mountain fold along the score lines of the A die cut and fold up to make the main body of the jukebox.

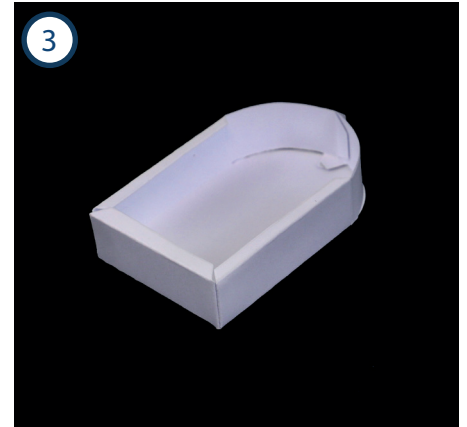

3. Assemble by sticking the tabs to their corresponding sides and ensuring the top halves curve to follow the shape of the jukebox.



4. Fold and stick the A1 die cut over the join of the top halves to hide it.



5. Add the remaining die cuts to the jukebox and decorate with the remaining dies as desired.

# Perfume Bottle

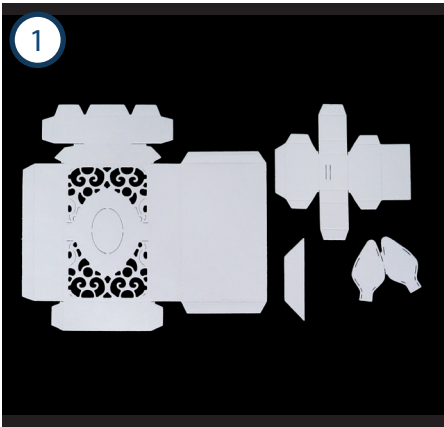

1. Cut the perfume bottle pieces ready to use.



2. Valley fold along all the score lines of the A die cut.



3. Valley fold along all the score lines of the C die cut. Secure by sticking the tabs to the corresponding sides.

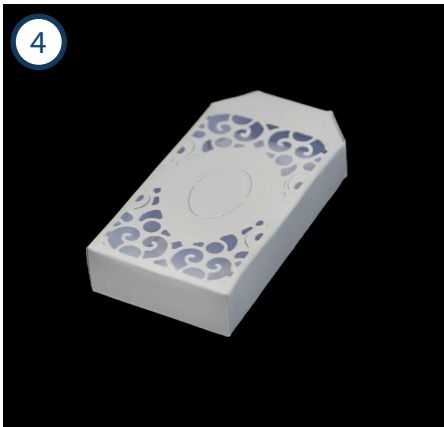

4. Assemble the bottle by sticking the tabs down to the corresponding sides on the A die cut.



5. Fold the D die cut and insert into the assembled C die cut. Stick into place.



6. Stick the completed lid onto the top of the perfume bottle.



# Teacup



1. Cut each of the teacup pieces ready to use.



2. Valley fold along the score lines of the main teacup piece.



3. Assemble the cup by sticking the tabs to their corresponding sides.



4. Stick one of the B die cuts onto the bottom of the cup.



5. Stick another B die cut onto the inside base of the cup to add extra strength.

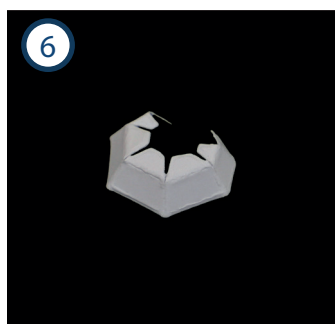

6. Mountain fold the score lines of the C die cut.



7. Stick the C die cut onto the bottom of the cup.

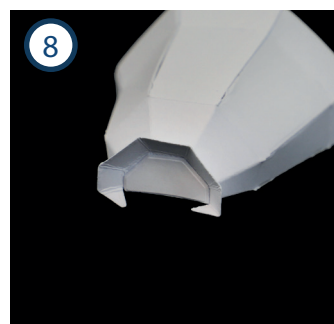

8. Stick the remaining B die cut into the middle to cover the tabs of the stand.



9. Stick the handle to the side of the cup with the tabs secured on the back. Decorate with the remaining dies as desired.

# Time Flutters

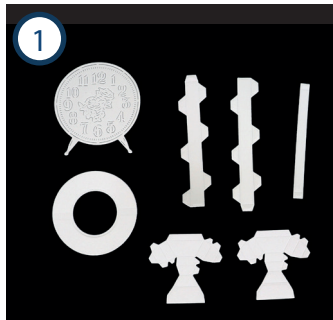

1. Cut each of the clock pieces ready to use. Cut a duplicate of dies B and D as shown.

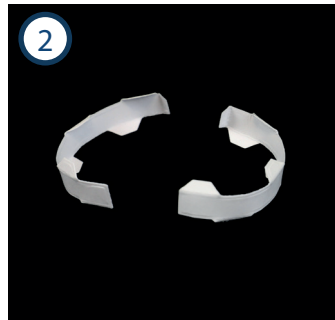

2. Curl the B die cuts into semicircles and valley fold the tabs.



3. Stick the pieces together to make one longer piece, using one end tab to the opposite end of the other piece.



4. Stick the long side piece to the reverse of the clock face. Use the remaining free tab to complete the circle.



5. Stick the back piece of the clock onto the reverse.



6. Fold along the score lines of both the D die cuts.



7. Assemble the pieces as shown and secure the tabs to hold them together.



8. Stick the assembled pieces on top of the clock using foam pads for extra dimension.

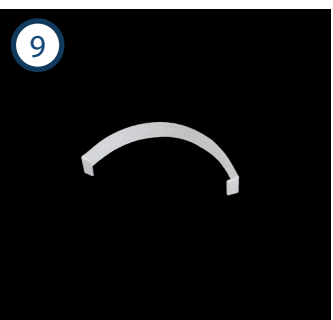

9. Curve the handle and fold the tabs inwards.



10. Stick the handle to the top of the clock. Use the extra dies to decorate as desired.

# Violin

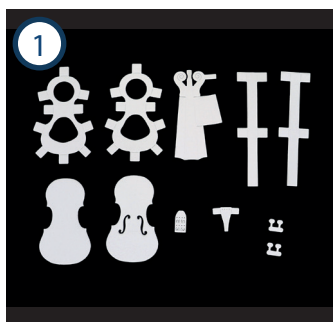

1. Cut each of the violin pieces ready to use as shown. Cut one copy of D with E to cut the flourish in.



2. Valley fold the tabs of the A die cuts.



3. Stick the pieces together using the tabs to make the basic body.

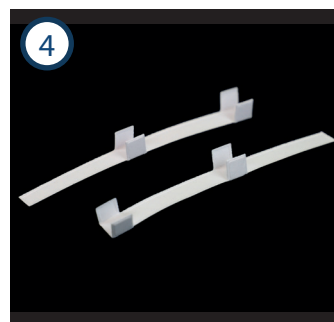

4. Valley fold the tabs of the B die cuts.



5. Stick the pieces onto the body. Use the tabs to secure them to the body and ensure to shape them as shown.

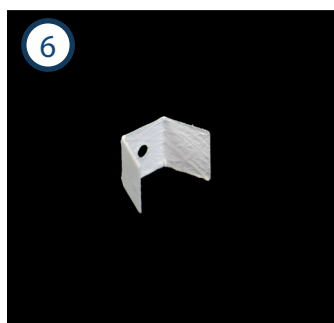

6. Valley fold along the score lines of the C die cut.



7. Stick the piece onto the bottom of the violin.



8. Stick the top and bottom pieces onto the violin, flourishes facing out.



9. Valley fold along the score lines of the F die cut.

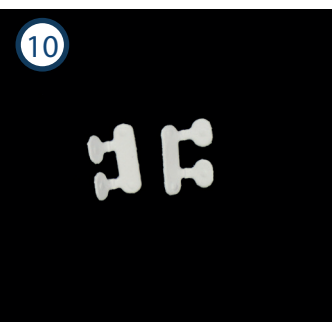

10. Score and lightly fold the 'pegs' of the J die cuts.



11. Assemble the F die cut and secure using the tabs. Stick onto the violin.



12. Add the pegs to the head. Fold and stick the remaining pieces onto the front. Use the X dies to decorate as desired.